

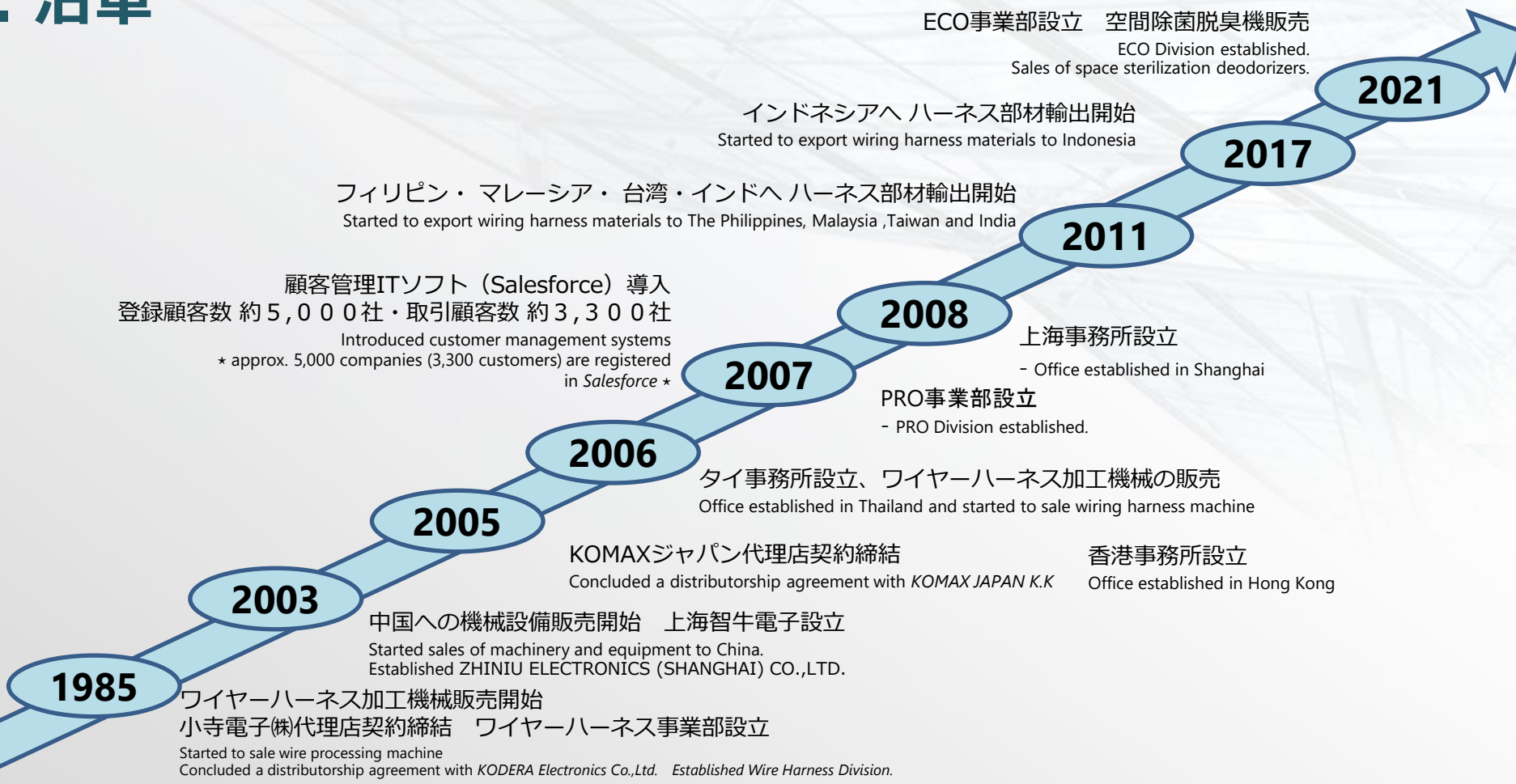

*USHIYAMA DENKI CO.,LTD.*  
*Company Profile*

ウシヤマ電機株式会社  
会社案内

# I. 沿革



電子部品販売 . 通信機器製造

創業者 牛山 修

Established Ushiyama Denki Co.,Ltd.

Sales of electronic components and manufacture of communication equipment



## Ⅱ. 会社概要 Company profile

- 会社名称                      ウシヤマ電機株式会社
- Company Name                USHIYAMA DENKI CO.,LTD.
  
- 代表者                        代表取締役社長 飯倉 一郎
- President                      Mr. Ichiro Iikura
  
- 所在地                        〒156-0043
- Head Office                    東京都世田谷区松原3-40-7 パインフィールドビル 9F  
9F Pinefield Bldg, 3-40-7 Matsubara, Setagaya-ku,  
Tokyo, Japan 156-0043
  
- U R L                         <http://www.ushiyama.co.jp> (日本) / <http://ushiyama-global.com> (海外)
  
- 創業年月日                    1979年7月26日
- Founded                        July 26,1979
  
- 資本金                        1000万円
- Capital                         JPY 10 million
  
- 社員数                        16人
- Employees
  
- 取引銀行                      きらぼし銀行 新宿支店 / 昭和信用金庫 下高井戸支店
- Main Bank                      Kiraboshi Bank, Ltd. (Shinjuku Branch) /  
Showa Shinkin Bank (Shimotakaido Branch)
  
- 事業内容                      ➤ 機械設備販売 及び メンテナンス
- Business                        Sale and maintenances of wire processing machines
- デジタルスケール販売 及び メンテナンス
- Sale and maintenances of digital scales
- 電装品部材販売
- Sale of wire harness materials and electronic materials
- W E B 関連事業
- WEB related business

## 営業所・事業所案内 Network of Operation in Japan and Overseas

◆ 本 社 ◆  
Head office

〒156-0043 東京都世田谷区松原 3-40-7 パインフィールドビル9F  
9F Pinefield Bldg, 3-40-7 Matsubara, Setagaya-ku, Tokyo, JAPAN 156-0043  
TEL 03-5355-6231 / FAX 03-5355-6232

◆九州営業所◆  
Kyushu Office

〒839-0851 福岡県久留米市御井町1805-2  
1805-2 Miimachi, Kurume-shi, Fukuoka, JAPAN 839-0951  
TEL 0942-80-1081 / FAX 0942-80-6236

◆上海事業所◆  
Shanghai Office

智牛電子(上海)技術有限公司 / ZHINIU ELECTRONICS (SHANGHAI) CO.,LTD.  
Floor4, Buil Ding 2, 621 Zhi Yuan Rd, Shanghai, China 200070  
TEL +86-21-5108-8933 / FAX +86-21-6540-9996

◆香港事業所◆  
Hong Kong  
Office

牛山電機有限公司 / USHIYAMA DENKI LIMITED  
Suite C, 6/F, Cameron Plaza, 23-25A Cameron Rd, Tsim Sha Tsui, Kowloon, H.K  
TEL +86-755-8268-5819 / FAX +86-755-8230-9538

◆タイ事業所◆  
Thailand Office

ANGEL INTERNATIONAL CO.,LTD  
786/13-14 Thonglor Tower, Sukhumvit 55 Rd, Klongton Nua,  
Watthana, Bangkok, Thailand 10110  
TEL +66-2714-9446 / FAX +66-2382-1258

◆オーストラリア  
事業所◆  
Australia Office

USHIYAMA DENKI CO., LTD GOLD COAST BRANCH  
Federation Ave. Broadbeach, QLD 4218, Australia

## Ⅲ. 近年の取り組み Current endeavor

- 多業界・多業種への設備提供を行う。(主に自動車・家電・通信・アミューズメント関連)
- Provide machinery for variety industries.  
Ex. automobile, home appliance, telecommunications, amusement etc...
- 顧客の需要に幅広く対応し、消耗部品や手動工具、ハーネス部品の提供も行う。
- Provide machine parts, hand tools and wire harness materials to meet various customer demands.
- 高速通信化に伴い、同軸ケーブル(DIN, FAKRA規格)の設備提供をする。
- Provide coaxial cable (DIN-Norm, FAKRA) as high-speed communication.
- グローバル化の促進・・・中国・台湾・タイ・インド・インドネシア・マレーシア等
- ▶ 海外工場への設備提供 ▶ 海外の新規顧客開拓
- Promote business globalization・・・China, Taiwan, Thailand, India, Indonesia, Malaysia etc...
- ▶ Provide machinery for overseas factories ▶ Open up new customers from overseas

**【登録顧客数 約5,000社、取引顧客数 約3,300社】**

**私たちは時代とお客様のニーズに合わせて変化していきます。**

***[approx. 5,000 registered companies including 3,300 customers]***

***We are coordinate according to customer's need.***





## IV. 特徴 Characteristic

大手企業から中小企業まで約5,000社の特徴に合わせたサービスを提供

Provide service in response to each feature of over 5,000 companies ranging from small firm to major corporation.

メーカーと一体になり、適切な設備の提案。カスタム品にも対応敏速で細やかなAfter-Salesサービス

Work in tandem with manufacturers and propose suitable equipment, including custom machine.

少数精鋭

Small number of professionals.

日本語・中国語・英語・韓国語の4カ国語でサポート

Support in 4 languages < Japanese, Chinese, English, Korean

適正な商品を適正な価格で適正な時期に品質・価格・納期(Q・C・D)で販売する

***Provide a reasonable number of good commodities at reasonable price timely !***

Quality

Cost

Delivery



# V. ワイヤーハーネス設備の納品実績

## Sales performance of wire processing machine

 株式会社 小寺電子製作所



Cable cutting fiber end universal stripping machine



FULL AUTOMATIC CRIMPING UNIT & SEAL INSERTION UNIT

 komax



ROTARY WIRE STRIPPER WITH 4X-BLADES

 UNION MACHINERY



Semi-Automatic Crimping Machine

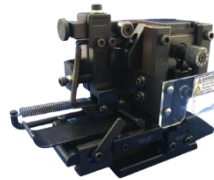

Applicator



Processed sample



FULL AUTOMATIC DOUBLE ENDS CLAMPING UNIT

 Schleuniger®



MEASURING CUTTING STRIP MACHINE



MULTISTRIP 9480 CUT&STRIP MACHINE

# V. ワイヤーハーネス設備の納品実績

## Sales performance of wire processing machine

**KM digitech**  
JAPAN



Tube Cutter

**NTU**  
日通電子工業株式会社



Sheathe Stripping Machine

**HE** 株式会社ヒースエンジニアリング  
HEATH ENGINEERING



Belt cutting machine

**Soltec** トレーソルテック株式会社



Crimp Force Monitor  
(Pressure Detector) CFM-Lite

**JCT** 日本連続端子株式会社



Semi-automatic terminal  
crimping machine "M-211J"



# V.ワイヤーハーネス部品の納品実績

## Sales performance of wire harness materials

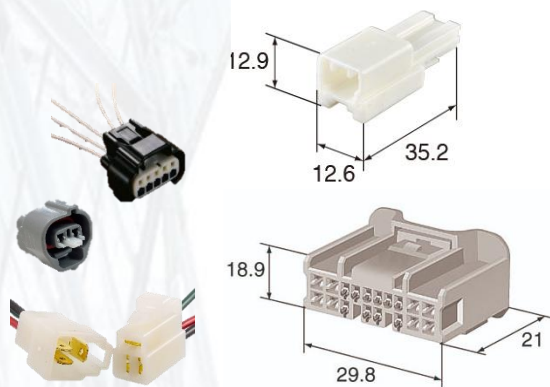

Connector | コネクタ

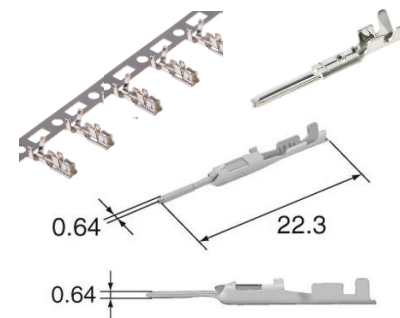
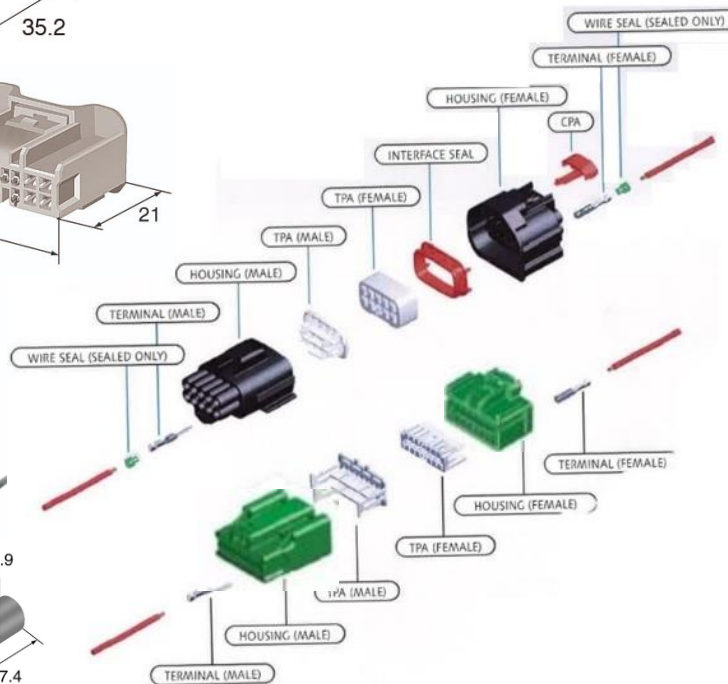

Terminal | 端子



Wire Seal | シール



Board Connector

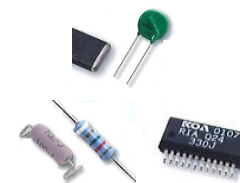

IC · Diode · Resistor

## VI.ワイヤーハーネス部品・電子部品 取扱メーカー

### Harnesses materials / Electronic materials Brand List

